

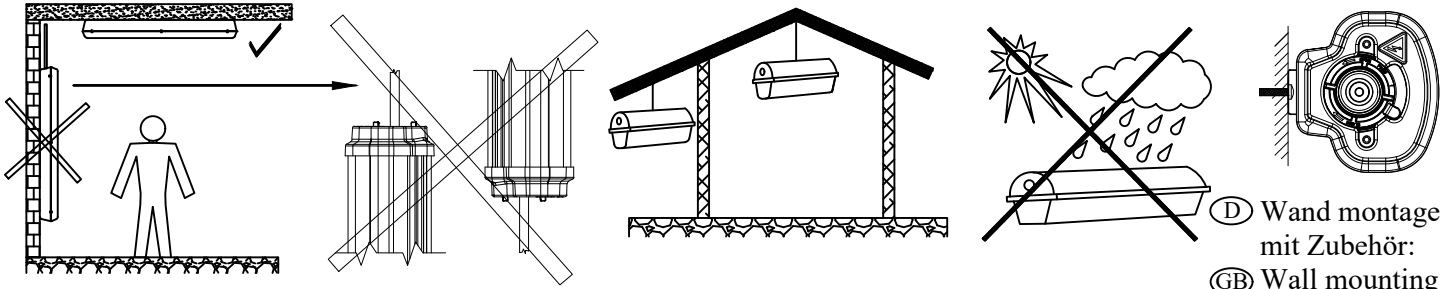

Serie 790 Xtrude

IP65



- Ⓓ Wand montage mit Zubehör:
 Ⓔ Wall mounting with accessories:
 Nr. 2009681

- Ⓓ Die Installation sollte durch einen Elektriker oder eine im Elektrobereich geschulte Person durchgeführt werden
 Ⓔ The installation should be carried out by an electrician or by a similar qualified person

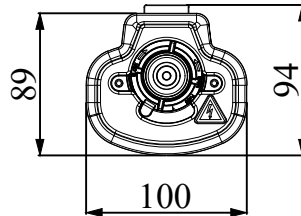

	A	B	C	D
2ft LED	648	350	575	200
4ft LED	1208	600	575	200
5ft LED	1488	850	575	200

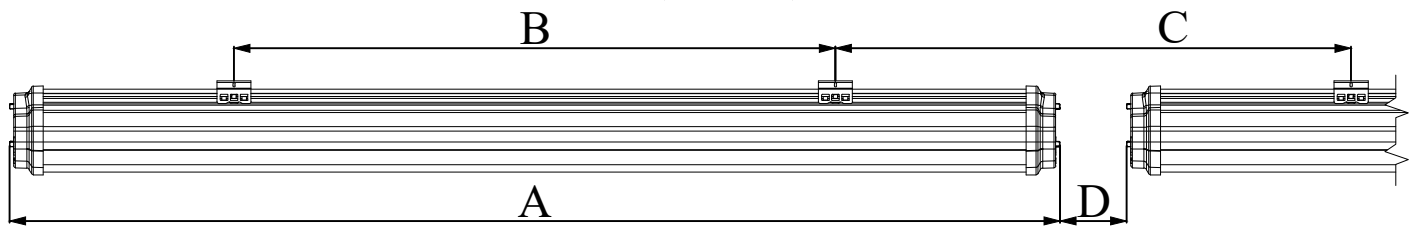

1

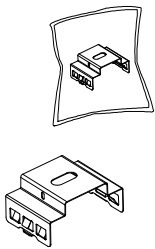

1.1

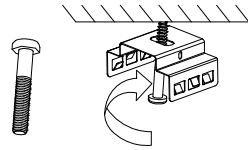

1.2

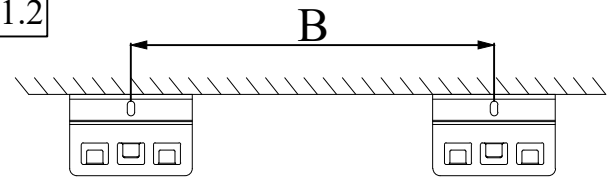

2

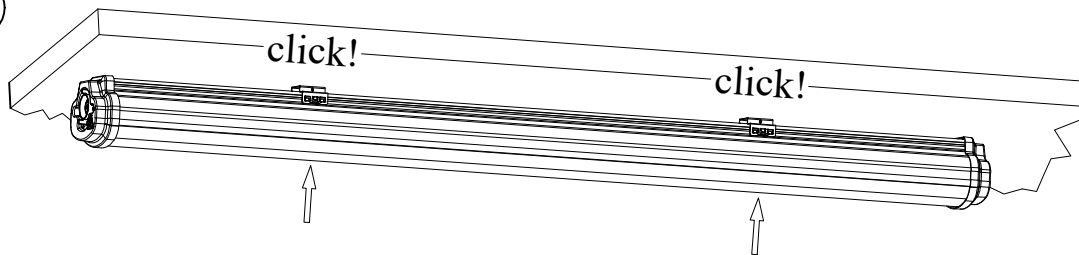

Option 1

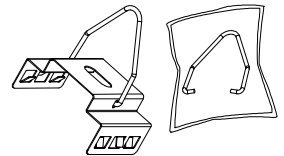

3

3.1

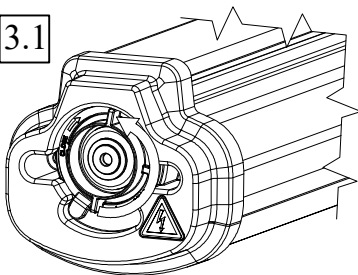

3.2

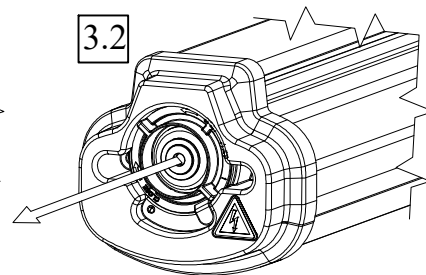

3.3

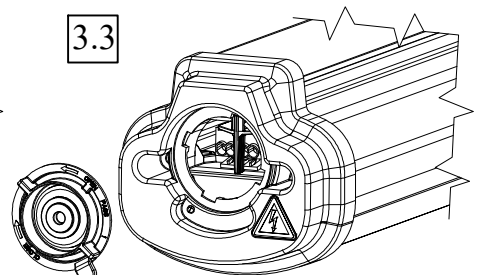

4

4.1

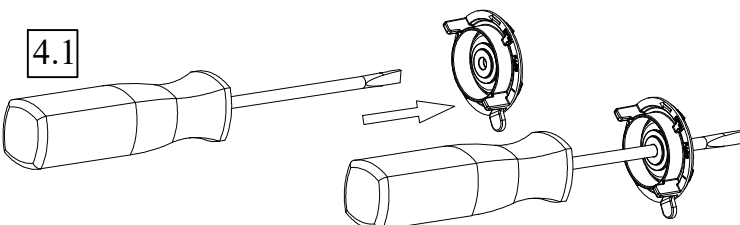

4.2

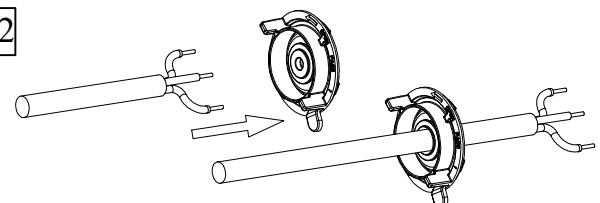

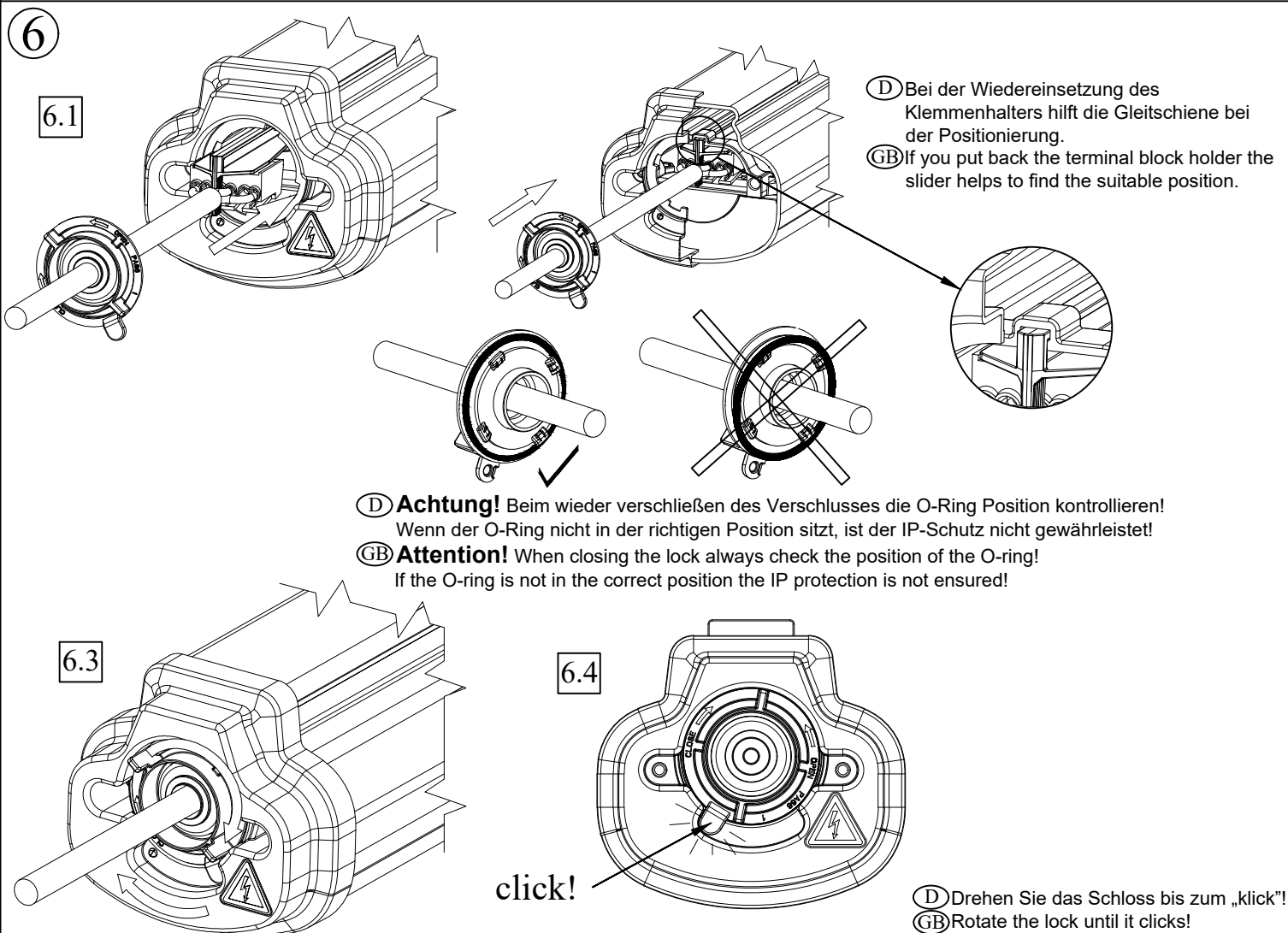
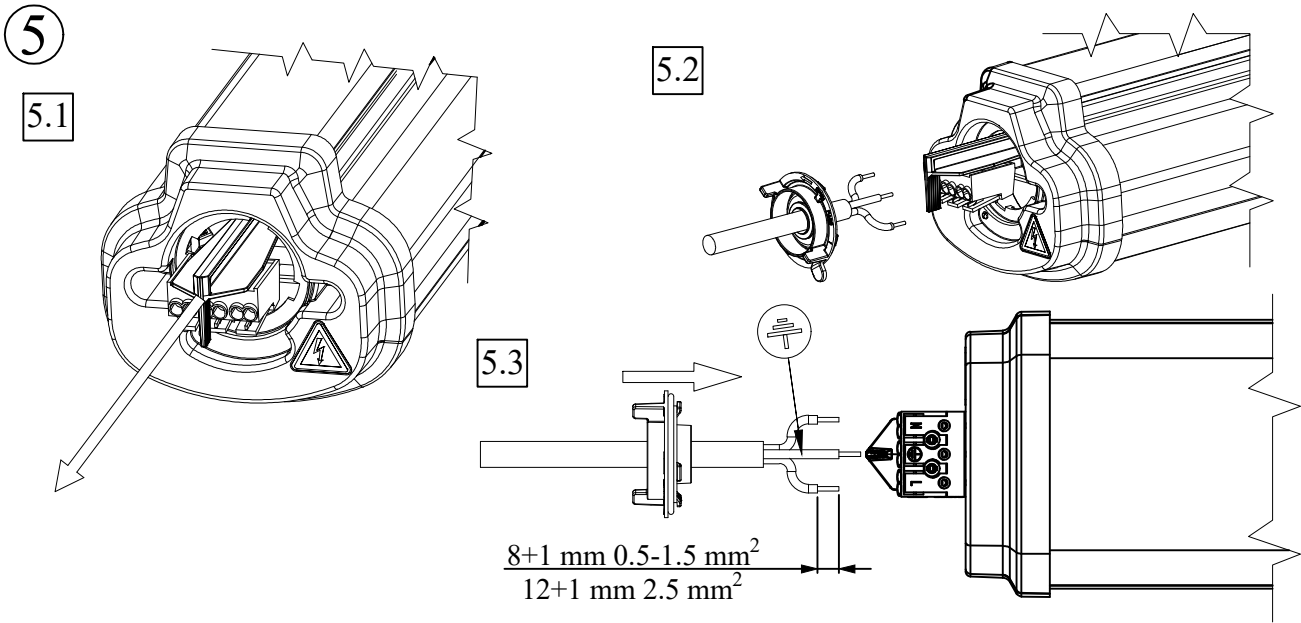

Materialhinweis

Chemische Einflüsse durch Kontakt oder durch in der Atmosphäre schwebende Stoffe und ungeeignete Reinigungsmethoden können zu einer Beschädigung der Leuchte führen! Verwenden Sie keine mässig bis stark laugen- und säurehaltigen Stoffe und keine Lösungsmittel oder Reinigungsmittel, welche Kunststoffe angreifen.

Luminaire materials

Aggressive chemicals, in direct contact with the luminaire or in the form of airborne substances can damage the fitting. So can unsuitable cleaning agents. Do not use any medium strength or concentrated alkaline or acidic solution nor any solvents. Do not use any cleansing agents that are aggressive on plastics.

VORSICHT, STROM SCHLAGGEFAHR!

Schalten Sie stets die Spannung vor Installation oder Reparatur ab!
Reparaturen der eingebauten Leuchtmittel dürfen nur durch den Hersteller oder dessen Dienstleister oder eine ähnlich qualifizierte Person durchgeführt werden.

CAUTION, RISK OF ELECTRIC SHOCK!

Disconnect supply before opening!
The light source contained in this luminaire shall only be replaced by the manufacturer or his service agent or similar qualified person.

